



ACCURIDE™



Assembled in USA

Maintenance and Troubleshooting Guide

Your only single source for industry-leading wheel end solutions.

STEEL & ALUMINUM WHEELS | DRUMS | HUBS | ROTORS | SLACK ADJUSTERS

Brake Adjustment After Installation

WARNING

Gunite Automatic Slack Adjusters should not be manually adjusted in an effort to correct excessive push rod stroke. Excessive pushrod stroke indicates that a problem exists with the automatic slack adjuster, installation, or with related foundation brake components, which manual adjustment will not fix. Manual adjustment of Gunite Automatic Slack Adjusters is a dangerous practice that could have serious consequences, because it gives the operator a false sense of security about the effectiveness of brakes which are likely to go out of adjustment again soon.

Adjust the Brakes As Follows:

1. Rotate the hex extension clockwise until the brake linings contact the brake drum. Back off the automatic slack by rotating the hex counterclockwise 1/2 turn.
2. Backing off the slack will require more than 15 ft. lb. of torque. When backing off the slack, a ratcheting sound will be heard.
3. Using a ruler, measure the distance from the face of the air chamber to the center of the large pin in the clevis (A) (See fig. 1). Make a 90 psi brake application and allow the chamber push rod to travel its maximum stroke. Measure to the center of the large pin (B). The difference between (A) and (B) is the push rod stroke. Check the chart on the second page for proper maximum stroke after adjustment of the brakes.

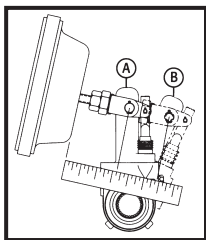

Figure 1 – Measuring Maximum Stroke

Measuring the Free Stroke

4. Free stroke is the amount of movement of the slack arm required to move the brake shoes against the drum. With brakes released, measure from the face of the chamber to the center of the clevis pin. Use a lever to measure the movement of the slack adjuster until the brake shoes contact the drum (See fig. 2). The difference between the released and applied measurements is the free stroke. The free stroke should be 3/8" - 5/8".

If the free stroke is good, but the applied stroke is too long, there is a problem with the foundation brake. Check the foundation brake for missing or worn components, cracked brake drums, or improper lining to drum contact.

If the free stroke is greater than the recommended distance (3/8" - 5/8"), a function test of the automatic slack adjuster should be performed (See function test on page 3).

If the free stroke is less than 3/8", a dragging brake can occur. Check to see that the manual adjustment procedure was followed correctly. Manually readjust the brake following the "Brake Adjustment After Installation" procedure in this pocket guide.

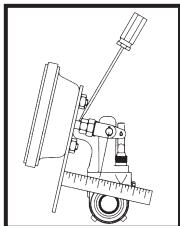

Figure 2 – Free Stroke

"STANDARD" CLAMP TYPE BRAKE CHAMBER DATA

Type	Outside Diameter	Rated Stroke	Maximum stroke at which brakes must be readjusted
9	5-1/4	1.75	1-3/8
12	5-11/16	1.75	1-3/8
16	6-3/8	2.25	1-3/4
20	6-25/32	2.25	1-3/4
24	7-7/32	2.25	1-3/4
30	8-3/32	2.50	2
36*	9	3.00	2-1/4

* Note: If type 36 chamber is used, slack length should be less than 6".

"LONG STROKE" CLAMP TYPE BRAKE CHAMBER DATA

Type	Outside Diameter	Rated Stroke	Maximum stroke at which brakes must be readjusted
16	6-3/8	2.50	2
20	6-25/32	2.50	2
24	7-7/32	2.50	2
24*	7-7/32	3.00	2-1/2
30*	8-3/32	3.00	2-1/2

* Note: Identified by square air port bosses.

Recommended Preventative Maintenance

Every Month, or 8,000 Miles

1. Check the condition of the foundation brakes, including drums, shoes and linings, cams, rollers, bushings, etc.
2. Check for structural damage of the housing, worn clevis, worn clevis bushings, and condition of the boot for cuts or tears. Replace if necessary.
3. After allowing the brake drum to cool to room temperature, check for correct chamber stroke following the procedure (See fig. 1). Due to different operating conditions, chamber stroke tests may be necessary at earlier intervals. See charts above for the recommended stroke measurements.

Every Six Months or 50,000 Miles

Gunite automatic slack adjusters are factory lubricated and extensively sealed to protect against dirt, water, salt, and other corrosive elements. Nevertheless, periodic lubrication is recommended.

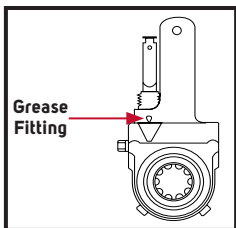

Figure 3 – Lubrication Point

NOTE

Lubrication should be performed using an NLGI 1 or 2 grade grease that has a working range of -40°F to 250°F. A grease containing Molybdenum Disulfide should not be used as it will likely have a negative impact on the function of key friction components and reduce the operational efficiency of the automatic slack adjuster.

Troubleshooting

Slack Adjuster Function Test

If the maximum stroke, with a 90 psi brake application is less than the distance shown in the chart on the left, the Gunite automatic slack adjuster is functioning properly.

1. The Gunite automatic slack adjuster should not require manual readjustment. If the maximum chamber stroke is within the range for the size chamber used (See fig. 1), the slack adjuster should not be manually readjusted.

If the chamber stroke exceeds the limit, measure the free stroke. If the free stroke is good, but the applied stroke is too long, there is a problem with the foundation brake. Check the foundation brake for missing or worn components, cracked brake drums, or improper lining to drum contact.

If the free stroke is **greater** than the recommended distance (3/8" - 5/8"), a function test of the automatic slack adjuster should be performed. To

test the function of the automatic slack adjuster, place a 7/16" box wrench on the hex extension and rotate it 3/4 of a turn counterclockwise. A ratcheting sound will be heard. Mark the 7/16" hex extension with chalk and apply the brakes several times and watch for the hex to rotate clockwise (See fig. 4). The hex extension must rotate clockwise. The adjustment is intentionally made in small increments so it will take several cycles to bring the adjuster within the stroke limit shown in the chart.

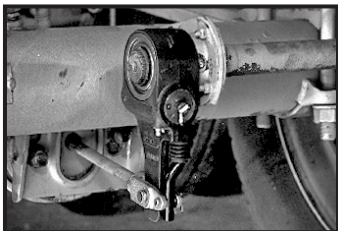

Figure 4 – Adjuster Function

If the free stroke is **less** than 3/8", a dragging brake can occur. Check to see that the manual adjustment procedure was followed correctly. Manually readjust the brake following the "Brake Adjustment After Installation" procedure.

2. Check the torque by attaching a torque wrench to the hex extension and turning it in a counterclockwise direction and record the measurement.
3. If the hex extension did not rotate clockwise or there is less than 15 ft. lb. of torque required to rotate the hex extension in the counterclockwise direction, the automatic slack must be replaced.
4. If the hex extension rotates clockwise and has a torque of greater than 15 ft. lb. when rotated counterclockwise, the slack is functioning properly. Check the foundation brake for proper function, worn cam bushing, pins and rollers, broken springs, worn quick connect clevis, worn clevis bushings and clevis pins. Repair as necessary and repeat the function test.
5. Readjust the brake after the function test.

Service Practices: Points and Precautions

1. Replace the automatic slack adjuster if it is not functioning properly, as described under "Slack Adjuster Function Test".
2. Replace the entire unit if damage is evident on the automatic slack housing or assembly.
3. The unit must be replaced if less than 15 ft. lb. of torque exists when turning the hex extension counterclockwise. Refer to the test as described under "Troubleshooting" (See fig. 5).

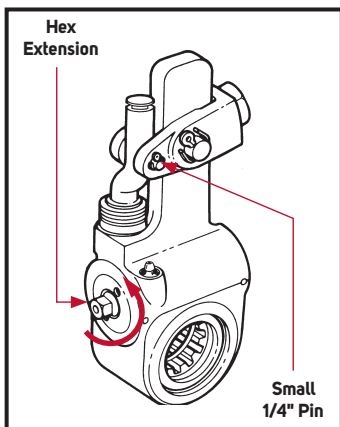

Figure 5 – ASA Drawing

4. Never operate the vehicle with small 1/4" pin missing from the clevis. The automatic slack adjuster will not maintain proper brake adjustment with either pin missing (ref. fig. 5).
5. Never attempt to disassemble the automatic slack adjuster. Factory setting cannot be duplicated in the field. Instead, replace the entire unit.

Lining/Drum Replacement Procedures

Special attention must be given to proper maintenance procedures of the automatic slack adjuster when you change brake linings and/or brake drums.

1. If the axle is equipped with spring brake chambers, manually cage the spring brakes, following the manufacturer's recommended procedures
2. Using a 7/16" socket, rotate the hex extension counterclockwise. You should have at least 15 ft. lb. resistance and a ratcheting sound will be heard as the hex extension is rotated.
3. Only back off the adjusting hex enough to allow the drum to clear the lining. Remove the brake drum. After the brake drum has been removed, rotate the hex extension clockwise until the cam turns over. This will allow the brake rollers to be in the release position.
4. Proceed with the lining change and/or brake drum replacement.
5. Rotate the hex extension clockwise until the brake linings contact the brake drum.
6. Back off the automatic slack by rotating the hex extension 1/2 turn counterclockwise. A ratcheting sound will be heard. This provides running clearance between the lining and the drum.
7. Using a ruler, measure the distance from the face of the air chamber to the center of the large pin in the clevis (A) (See fig. 6). Make a 90 psi brake application and allow the air chamber to travel its maximum stroke. Measure to the center of the large pin (B). The difference between (A) and (B) is the push rod stroke. Check the following charts for proper maximum stroke after adjustment of the brakes.
8. Manually uncage the spring brakes.

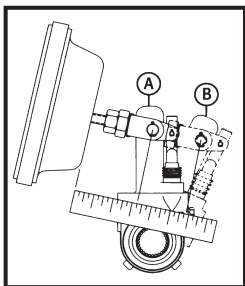

Figure 6 – Measuring Maximum Stroke

“STANDARD” CLAMP TYPE BRAKE CHAMBER DATA

Type	Outside Diameter	Rated Stroke	Maximum stroke at which brakes must be readjusted
9	5-1/4	1.75	1-3/8
12	5-11/16	1.75	1-3/8
16	6-3/8	2.25	1-3/4
20	6-25/32	2.25	1-3/4
24	7-7/32	2.25	1-3/4
30	8-3/32	2.50	2
36*	9	3.00	2-1/4

* Note: If type 36 chamber is used, slack length should be less than 6".

"LONG STROKE" CLAMP TYPE BRAKE CHAMBER DATA

Type	Outside Diameter	Rated Stroke	Maximum stroke at which brakes must be readjusted
16	6-3/8	2.50	2
20	6-25/32	2.50	2
24	7-7/32	2.50	2
24*	7-7/32	3.00	2-1/2
30*	8-3/32	3.00	2-1/2

* Note: Identified by square air port bosses.

Roadside Brake Adjustment

If the driver has to adjust brakes on the road, the following procedure is recommended:

NOTE

If the vehicle is equipped with an automatic slack adjuster, use a pry bar to pull on the slack adjuster. If movement is more than 5/8", the following manual adjustment procedure should be made. If the automatic slack adjuster needs adjustment, inform maintenance personnel.

1. Block the wheels or mechanically secure the vehicle. On the brakes to be adjusted, spring brakes must be mechanically caged or released with air.
2. Rotate the adjusting hex clockwise until the brake shoes contact the drum. Using a pry bar, pull on the slack adjuster by hand to make sure it will not move. If there is movement, adjustment was made in the wrong direction. Therefore, the adjusting mechanism must be turned in the opposite direction. Tap the brake drum with a wrench. You should hear a dull clunk—indicating the brake linings are tight against the drum.
3. Rotate the adjusting mechanism counter-clockwise a small amount at a time, while tapping on the brake drum with a wrench in between adjustments. Stop when you hear a clear ringing sound from the brake drum when tapped with a wrench.
4. Using a pry bar, pull on the slack adjuster by hand. If movement is more than 5/8", adjustment was not done properly or there is a problem with the foundation brake.

NOTE

Some brake chamber push rods are marked to warn of an over-stroke condition. While the marking themselves may vary, the marking system has two basic features: (1) There is a mark on the brake chamber push rod near its clevis attachment to signal that it incorporates a stroke alert indicator (See fig. 7, diagram B). (2) There also is a mark on the brake chamber push rod—opposite its clevis attachment end—which is exposed from the brake chamber wherever over-stroke occurs (See fig. 7, diagram C).

Figure 7

Brakes Released

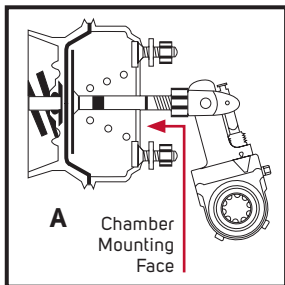

Brakes Applied

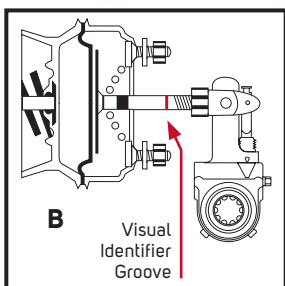

Improper Installation or Brakes Out of Adjustment

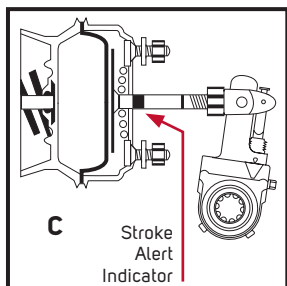

Scan this code to search Automatic Slack Adjuster on accuridecorp.com.



Your only single source for industry-leading wheel end solutions.

STEEL & ALUMINUM WHEELS | DRUMS | HUBS | ROTORS | SLACK ADJUSTERS

For more information: (800) 677-3786 | accuridecorp.com

Gunite | 302 Peoples Avenue | Rockford, IL 61104

